



# **TRUFAST<sup>®</sup>**

## **PRODUCT CATALOG**



**FASTENING SOLUTIONS FOR COMMERCIAL ROOFING**

# ABC US HISTORY



Founded in 1981 in Bryan, OH, TRUFAST® began manufacturing and distributing unique and better performing fastening solutions for the commercial roofing industry. In January of 2006, German-based ALTENLOH, BRINCK & CO. (ABC) – a global leader in the manufacturing of fastening solutions for the automotive and construction industries, and widely recognized for its SPAX brand – acquired the ongoing TRUFAST operation.

Today, TRUFAST fasteners, adhesives, and accessories continue to be sold through commercial roofing and building material distributors throughout North America and Western Europe, as well as supplied under the private labels of leading OEM commercial roofing systems manufacturers.

Altenloh, Brinck & Co. US are proud to manufacture and distribute engineered fasteners under the SPAX brand for the residential construction market, the TRUFAST brand for the commercial roofing industry and the TRUFAST Walls brand for exterior building envelopes and facades.



*TRUFAST® began selling commercial roofing screws.* **1981**

**2006** *Altenloh, Brinck & Co. purchased TRUFAST®.*

*U.S. companies merged into ABC US, Inc.* **2010**

**2011** *Completion of a 33,000 sq. ft. expansion and modernization of the Bryan, OH, manufacturing facility.*

*Acquisition of ES Products Company, manufacturer of specialty fastening solutions for low density, low slope roof decks.* **2013**

**2015** *Completion of a 50,000 sq. ft. expansion at the Pioneer, OH, heat treat facility.*

*ABC US acquired Rodenhouse® innovative fastening solutions.* **2017**



**2021** *Rodenhouse® rebranded to TRUFAST® Walls. 65,000 sq. ft. added to the heat treat facility in Pioneer, OH, for a state-of-the-art packaging facility.*











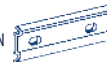









# TABLE OF CONTENTS

Roofing Fastener Reference Guide .....	2-3
Roofing Fasteners .....	4-9
#12 DP Drill Point Roofing Fasteners, Phillips Truss Head .....	4
#12 PA Pre-Assembled Screws and Plates .....	4
#14 HD Drill Point Roofing Fasteners, Phillips Truss Head .....	5
#14 HDB-SS Stainless Steel Heavy Duty Bi-Metal, Phillips Truss Head .....	5
#15 EHD Drill Point Roofing Fasteners, Phillips Truss Head .....	6
PFC Purlin Fastener .....	7
1/4" Concrete Spike .....	7
TL Lightweight Fasteners & Plates .....	8
100 Count Packages — Roofing Fasteners & Plates .....	9
Stress Plates .....	10
Batten Bar .....	10
Induction Welder, Plates, and Cardboard Discs .....	11
Termination Bar & ZAMAC Masonry Nailins .....	12
Tools & Driver Bits .....	13
SIP Fasteners .....	14-15
SIPTP Thread Point Fasteners .....	14
SIPLD Light-duty Drill Point Fasteners .....	15
SIPHD Heavy-duty Drill Point Fasteners .....	15
Base Sheet Fasteners and Accessories .....	16
VERSA-FAST® Fasteners and Plates .....	17
Adhesive & Sealants .....	18-19
TRUFAST® Roofing Adhesives .....	18
DuPont® INSTA STIK® Quik Set Roofing Adhesive .....	19
DuPont® FROTH-PAK Spray Polyurethane Sealant .....	19
DuPont® TILE BOND .....	19
Rooftop Drains .....	20-22
The TRUFAST Commitment .....	23
Notes .....	24-25
Spanish Roofing Fastener Reference Guide .....	26-27
Standard Freight & Order Policies .....	28

FASTENERS	APPLICATIONS	THREADS PER INCH/STYLE	HEAD STYLE	USE WITH	STANDARD LENGTHS	MATERIAL/ FINISH	CODE APPROVALS
<p>#12 DP ROOFING FASTENERS</p>	STEEL (16 GAUGE OR THINNER)	13 SINGLE LEAD	#3 PHILLIPS FLAT TRUSS HEAD	METAL PLATE	1-5/8", 2-1/4", 3", 4", 5", 6", 7", 8"	CARBON STEEL BLACK E-Coat	FM, MIAMI-DADE CE - ETA 19/0616 State of Florida - FL#: 4500
<p>#14 HD ROOFING FASTENERS</p>	STEEL (16 - 24 GAUGE), WOOD, OR CONCRETE	13 SINGLE LEAD	#3 PHILLIPS FLAT TRUSS HEAD	METAL PLATE BATTEN BAR	1-1/4", 1-1/2", 2", 2-1/2", 3", 3-1/2", 4", 4-1/2", 5", 5-1/2", 6", 7", 8", 9", 10", 11", 12"	CARBON STEEL BLACK E-Coat	FM, MIAMI-DADE CE - ETA 19/0616 State of Florida - FL#: 4500
<p>#14 STAINLESS STEEL BI-METAL ROOFING FASTENERS</p>	STEEL (18 GAUGE OR THINNER) OR WOOD	13 SINGLE LEAD	#3 PHILLIPS FLAT TRUSS HEAD	METAL PLATE BATTEN BAR	1-1/2", 2", 3", 4", 5", 6", 7", 8", 9", 10", 12"	316 STAINLESS STEEL	FM, MIAMI-DADE CE - ETA 19/0616 State of Florida - FL#: 4500
<p>#15 EHD ROOFING FASTENERS</p>	STEEL (18 GAUGE OR THINNER) OR WOOD	13 SINGLE LEAD BUTTRESS	#3 PHILLIPS FLAT TRUSS HEAD	METAL PLATE BATTEN BAR	2", 3", 4", 5", 6", 7", 8", 9", 10", 11", 12", 14", 16", 18", 20", 22", 24"	CARBON STEEL BLACK E-Coat	FM, MIAMI-DADE CE - ETA 19/0616 State of Florida - FL#: 4500
<p>(PA) PRE-ASSEMBLED</p>	STEEL (16 GAUGE OR THINNER) OR WOOD	13 SINGLE LEAD	3" PHILLIPS FLAT TRUSS HEAD	METAL PLATE	1-5/8", 2-1/4", 2-7/8", 3-1/4", 3-3/4", 4-1/2", 5", 6", 7", 8"	SCREW-CARBON STEEL & BLACK E-Coat; PLATE- GALVALUME	FM State of Florida - FL#: 4500 MIAMI-DADE
<p>1/4" CONCRETE SPIKE ROOFING FASTENER</p>	CONCRETE	N/A	TRUSS HEAD	METAL PLATE BATTEN BAR	1-1/4", 1-1/2", 2", 2-1/2", 3", 3-1/2", 4", 4-1/2", 5-1/2", 6", 6-1/2", 7", 7-1/2", 8", 9", 10", 11", 12", 13", 14", 15", 16"	CARBON STEEL BLACK E-Coat	FM
<p>TL ROOFING FASTENERS</p>	TECTUM® & LT. WT. CONCRETE	TAPERED ROOT WITH BUTTRESS	1/4" SQUARE DRIVE FLAT HEAD	METAL PLATE	2", 2-1/2", 3", 3-1/2", 4", 4-1/2", 5", 5-1/2", 6", 6-1/2", 7", 7-1/2", 8", 8-1/2", 9", 9-1/2", 10", 11", 12", 13", 14"	NYLON	FM MIAMI-DADE State of Florida - FL#: 4500
<p>VERSA-FAST® FASTENERS</p>	LWIC & GYPSUM	4 SINGLE LEAD	#2 PHILLIPS	VERSA-FAST® METAL PLATE	2-1/4", 3-1/4", 4-1/4", 5-1/4", 6-1/4"	CARBON STEEL BLACK E-Coat	FM MIAMI-DADE State of Florida - FL#: 4500
<p>#12 PURLIN ROOFING FASTENERS</p>	STEEL (3/16" THICK OR THINNER)	24 SINGLE LEAD	#3 SQUARE DRIVE PANCAKE HEAD	METAL PLATE BATTEN BAR	1-3/8", 2-3/4", 3-3/4", 4-3/4", 5-3/4", 6-3/4", 7-3/4", 8-3/4", 9-3/4"	CARBON STEEL BLACK E-Coat	FM, MIAMI-DADE CE - ETA 19/0616 State of Florida - FL#: 4500
<p>SIP LD FASTENERS</p>	CORRUGATED STEEL, WOOD & CONCRETE	10 SINGLE LEAD	T-STAR #30 PANCAKE HEAD	T-STAR #30 PANCAKE HEAD	2-1/4", 3", 3-1/4", 3-1/2", 4", 4-1/4", 4-1/2", 5", 5-1/2", 6", 6-1/2", 7", 7-1/2", 8", 8-1/2", 9", 9-1/2", 10", 11", 12", 13", 14", 15", 16", 17", 18"	CARBON STEEL BLACK E-Coat	FM, MIAMI-DADE CE - ETA 19/0616 State of Florida - FL#: 4500
<p>SIP HD FASTENERS</p>	STRUCTURAL STEEL	20 SINGLE LEAD	T-STAR #30 PANCAKE HEAD	T-STAR #30 PANCAKE HEAD	2-1/4", 3-1/4", 4-1/4", 5-1/4", 6", 8", 9-3/4", 11-3/4", 13-3/4"	CARBON STEEL BLACK E-Coat	FM, MIAMI-DADE CE - ETA 19/0616 State of Florida - FL#: 4500
<p>SIP TP FASTENERS</p>	WOOD	7 SINGLE LEAD	T-STAR #30 PANCAKE HEAD	T-STAR #30 PANCAKE HEAD	2", 2-1/2", 3", 3-1/2", 4", 4-1/2", 5", 5-1/2", 6", 6-1/2", 7", 7-1/2", 8", 8-1/2", 9", 10", 11", 12", 13", 14", 15", 16", 17"	CARBON STEEL BLACK E-Coat	FM, MIAMI-DADE CE - ETA 19/0616 State of Florida - FL#: 4500

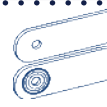
BASE SHEET FASTENER	APPLICATIONS	STANDARD LENGTHS	HEAD / DISK DIAMETER	MATERIAL / FINISH	CODE APPROVALS
TWIN LOC-NAIL 	LWIC, TECTUM® & GYPSUM	1.4", 1.8"	2.7"	GALVALUME® - PLATE, COATED STEEL - TUBE STAINLESS STEEL - LOCKING STAPLE	FM MIAMI-DADE
FM 	LWIC & GYPSUM	FM-75 - 1.2" FM-90 - 1.7"	2.7"	GALVALUME® - PLATE POLYMER COATED STEEL - LEGS	FM MIAMI-DADE

PLATES	APPLICATIONS	USE WITH	CODE APPROVALS	BARS	FEATURE	THICKNESS	MATERIAL	CODE APPROVALS
3" METAL INSULATION PLATE 	COVERBOARDS, INSULATION, & BUR BASE SHEETS TO THE SUBSTRATE	DP, HD, HD-SS, EHD, TS250	FM, MIAMI-DADE CE - ETA 19/0616 State of Florida - FL#: 4500	TB-50 TERMINATION 	SEALANT LEDGE	.050"	EXTRUDED ALUMINUM	N/A
3" RECESSED METAL INSULATION PLATE 	INSULATION TO THE SUBSTRATE	DP, DPH, HD, HD-SS, EHD, TS250	FM, MIAMI-DADE CE - ETA 19/0616 State of Florida - FL#: 4500	TB-75 TERMINATION 	SEALANT LEDGE	.075"	EXTRUDED ALUMINUM	N/A
3" TL INSULATION PLATE 	COVERBOARDS, INSULATION, BUR BASE SHEETS TO CEMENTITIOUS WOOD FIBER, GYPSUM, & LIGHTWEIGHT CONCRETE SUBSTRATE	TL	FM MIAMI-DADE State of Florida - FL#: 4500	TB-75-SS TERMINATION 	SEALANT LEDGE	.075"	STAINLESS STEEL	N/A
3" TL INSULATION PLATE 	COVERBOARDS, INSULATION, BUR BASE SHEETS TO CEMENTITIOUS WOOD FIBER, GYPSUM, & LIGHTWEIGHT CONCRETE SUBSTRATE	TL	FM MIAMI-DADE State of Florida - FL#: 4500	TB-90 TERMINATION 	FLAT	.090"	EXTRUDED ALUMINUM	N/A
VERSA-FAST® 3" PLATES 	COVERBOARDS, INSULATION, & BUR BASE SHEETS TO LWIC & GYPSUM SUBSTRATES	VERSA-FAST® FASTENERS	FM MIAMI-DADE State of Florida - FL#: 4500	TB-100 TERMINATION 	SEALANT LEDGE	.075"	EXTRUDED ALUMINUM	N/A
2" METAL SEAM PLATE 	REINFORCED & NON-REINFORCED SINGLE-PLY MEMBRANES TO THE SUBSTRATE	HD, HD-SS, EHD, PF, TS250	FM, MIAMI-DADE CE - ETA 19/0616 State of Florida - FL#: 4500	TB-125 TERMINATION 	FLAT	.125"	EXTRUDED ALUMINUM OR STAINLESS STEEL	N/A
2" BARBED SEAM PLATE 	REINFORCED SINGLE-PLY & MODIFIED BITUMINOUS MEMBRANES TO THE SUBSTRATE	HD, HD-SS, EHD, PF, TS250	FM, MIAMI-DADE CE - ETA 19/0616 State of Florida - FL#: 4500	TB-125-SS TERMINATION 	FLAT	.125"	STAINLESS STEEL	N/A
2" TL SEAM PLATE 	REINFORCED SINGLE-PLY & MODIFIED BITUMINOUS MEMBRANES TO CEMENTITIOUS WOOD FIBER, GYPSUM, & LIGHTWEIGHT CONCRETE SUBSTRATE	TL	FM MIAMI-DADE State of Florida - FL#: 4500	RD-100 DRAIN 	STONE BALLAST RETAINER	.125"	EXTRUDED ALUMINUM	N/A
2.4" BARBED METAL SEAM PLATE 	REINFORCED SINGLE-PLY & MODIFIED BITUMINOUS MEMBRANES TO THE SUBSTRATE	HD, HD-SS, EHD, PF, TS250	FM, MIAMI-DADE CE - ETA 19/0616 State of Florida - FL#: 4500	BATTEN BAR 	FLAT OR RECESSED	.043"	GALVALUME®	FM MIAMI-DADE CE - ETA 19/0616 State of Florida - FL#: 4500-R1
INDUCTION WELD PLATE 	PVC OR TPO MEMBRANES	HD, EHD, PF	FM, MIAMI-DADE State of Florida - FL#: 4500	<b>TOOLS &amp; ACCESSORIES</b> <ul style="list-style-type: none"> <li>SIP SHORTY TOOL</li> <li>SHORTY TOOL</li> <li>PA STAND UP TOOL</li> <li>SETTER TOOL</li> <li>PA BAG</li> <li>BASE SHEET FASTENER TOOL</li> </ul>				
				<b>TRUFAST® PA SYSTEM™</b> <ul style="list-style-type: none"> <li>PA (pre-assembled fasteners are faster to install than individual screws and plates.</li> <li>System and tools require no special training.</li> <li>Improves ergonomics and worker productivity.</li> <li>Simple, lightweight, and portable Standup Tool.</li> <li>Reliable and economical as compared with cumbersome, complicated automated equipment.</li> <li>Allows one-hand operation to drive fasteners on flat or sloping surfaces.</li> <li>For use with #3 Phillips head.</li> <li>Easy depth control helps ensure proper fastener tightness.</li> <li>Compact and lightweight</li> </ul>				
				<p>TRUFAST® is a brand of Altenloh, Brinck &amp; Co. US, Inc., specializing in engineered fastening solutions and accessories for the commercial roofing industry. Other brands of ABC US include SPAX® and TRUFAST® Walls, engineered fastening solutions for the construction industry and building envelope, respectively.</p>  <p>ALTENLOH, BRINCK &amp; CO. US, INC.</p>				

# ROOFING FASTENERS

The #12 DP Roofing Fasteners are specifically engineered to secure insulation, coverboards, and base sheets to corrugated steel (16-22 gauge) and wood substrates. Featuring a #2 double flute self-drilling point and exclusive tapered entry thread design, they penetrate steel quickly and offer exceptional back-out resistance.

## DP #12 Drill Point, #3 Phillips Truss Head, Black E-coat

Length	Part No.	Pkg Qty/Type	Wgt/Pkg
1-5/8"	DP-1625	1000 / Bucket	12.5 lbs.
2-1/4"	DP-2250	1000 / Bucket	16.1 lbs.
3"	DP-3000	1000 / Bucket	20.2 lbs.
4"	DP-4000	1000 / Bucket	25.9 lbs.
5"	DP-5000	1000 / Bucket	32.0 lbs.
6"	DP-6000	1000 / Bucket	37.5 lbs.
7"	DP-7000	500 / Bucket	22.5 lbs.
8"	DP-8000	500 / Bucket	24.7 lbs.

One (1) #3 Phillips BIT-PH3-2000 included per pkg.



TRUFAST originated the combination of the pre-assembled fastener and insulation plate to increase the productivity of attaching insulation to metal and wood roof decks. Pre-assembled fasteners and plates feature a #12 drill point fastener with a 3" Galvalume™ plate and are available in #3 Phillips Truss Head (PA) style. TRUFAST offers a complete "system solution", that is simple, economical, and ergonomic, to increase productivity in the mechanical attachment of roof insulation.

## PA Pre-Assembled Screws & Plates

### #12 DP #3 Phillips Truss Head Fastener with 3" Plate

Length	Part No.	Pkg Qty/Type	Wgt/Pkg
1-5/8"	PA-1625	250 / Carton	15.0 lbs.
2-1/4"	PA-2250	250 / Carton	15.9 lbs.
3"	PA-3000	250 / Carton	16.8 lbs.
4"	PA-4000	250 / Carton	18.0 lbs.
5"	PA-5000	250 / Carton	20.0 lbs.
6"	PA-6000	250 / Carton	21.4 lbs.
7"	PA-7000	200 / Carton	18.7 lbs.
8"	PA-8000	200 / Carton	19.6 lbs.

One (1) #3 Phillips BIT-PH3-2000 included with every 1,000 fasteners.



# ROOFING FASTENERS

The #14 HD Fastener is engineered to secure insulation, coverboards, base sheets and single-ply roof membrane systems to corrugated steel (16 - 22 ga.), wood, and concrete substrates. Featuring a #2 double flute self-drilling point and exclusive tapered entry thread design, they penetrate steel quickly and offer exceptional back-out resistance.

## HD #14 Heavy Duty Drill Point, #3 Phillips Truss Head, Black E-coat

Length	Part No.	Pkg Qty/Type	Wgt/Pkg
1-1/4"	HD-1250	1000 / Bucket	11.9 lbs.
1-1/2"	HD-1500	1000 / Bucket	14.2 lbs.
2"	HD-2000	1000 / Bucket	16.8 lbs.
2-1/2"	HD-2500	1000 / Bucket	20.7 lbs.
3"	HD-3000	1000 / Bucket	25.0 lbs.
3-1/2"	HD-3500	1000 / Bucket	29.5 lbs.
4"	HD-4000	1000 / Bucket	31.8 lbs.
4-1/2"	HD-4500	1000 / Bucket	35.7 lbs.
5"	HD-5000	1000 / Bucket	38.7 lbs.
5-1/2"	HD-5500	1000 / Bucket	43.6 lbs.
6"	HD-6000	1000 / Bucket	45.7 lbs.
7"	HD-7000	500 / Bucket	26.9 lbs.
8"	HD-8000	500 / Bucket	30.3 lbs.
9"	HD-9000	250 / Bucket	18.3 lbs.
10"	HD-10000	250 / Bucket	19.4 lbs.
11"	HD-11000	250 / Bucket	21.9 lbs.
12"	HD-12000	250 / Bucket	23.7 lbs.

One (1) #3 Phillips BIT-PH3-2000 included per pkg.



The #14 HD Stainless Steel Bi-Metal Roofing Fastener is made of 316 austenitic stainless steel alloy with a hardened carbon steel drill point. This all purpose roofing fastener is engineered to secure insulation, coverboards, base sheets and single-ply roof membrane systems to corrugated steel (18-24 ga.) and wood substrates. The #2 double flute self-drilling point and exclusive tapered entry thread design penetrates steel quickly.

## HDB-SS #14 Heavy Duty Bi-Metal, #3 Phillips Truss Head

Length	Part No.	Pkg Qty/Type	Wgt/Pkg
1-1/2"	HDB-1500-SS	1000 / Bucket	15.7 lbs.
2"	HDB-2000-SS	1000 / Bucket	19.2 lbs.
3"	HDB-3000-SS	1000 / Bucket	26.3 lbs.
4"	HDB-4000-SS	1000 / Bucket	33.4 lbs.
5"	HDB-5000-SS	1000 / Bucket	40.8 lbs.
6"	HDB-6000-SS	1000 / Bucket	47.7 lbs.
7"	HDB-7000-SS	500 / Bucket	28.0 lbs.
8"	HDB-8000-SS	500 / Bucket	31.5 lbs.
10"	HDB-10000-SS	250 / Bucket	19.9 lbs.
12"	HDB-12000-SS	250 / Bucket	23.4 lbs.

One (1) #3 Phillips BIT-PH3-2000 included per pkg.

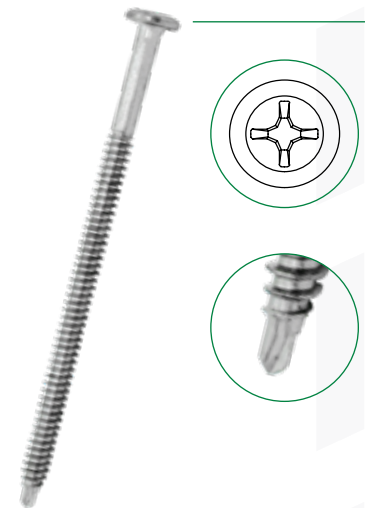

# ROOFING FASTENERS

The #15 EHD Fastener is engineered for lap attachment to corrugated steel (18 – 22 ga.) and wood substrates in higher wind uplift roof assemblies. Featuring a #2 double flute self-drilling point and exclusive tapered entry thread design, they penetrate steel quickly and offer exceptional back-out resistance.

## EHD #15 Extra Heavy Duty Drill Point, #3 Phillips Truss Head, Black E-coat

Length	Part No.	Pkg Qty/Type	Wgt/Pkg
2"	EHD-2000	1000 / Bucket	23.6 lbs.
3"	EHD-3000	1000 / Bucket	33.3 lbs.
4"	EHD-4000	1000 / Bucket	43.2 lbs.
5"	EHD-5000	1000 / Bucket	52.8 lbs.
6"	EHD-6000	500 / Bucket	31.8 lbs.
7"	EHD-7000	500 / Bucket	36.6 lbs.
8"	EHD-8000	500 / Bucket	41.4 lbs.
9"	EHD-9000	250 / Bucket	23.7 lbs.
10"	EHD-10000	250 / Bucket	26.1 lbs.
11"	EHD-11000	250 / Bucket	28.5 lbs.
12"	EHD-12000	250 / Bucket	30.9 lbs.
14"	EHD-14000	250 / Carton	35.6 lbs.
16"	EHD-16000	250 / Carton	40.4 lbs.
18"	EHD-18000	250 / Carton	45.3 lbs.
20"	EHD-20000	250 / Carton	50.0 lbs.
22"	EHD-22000	250 / Carton	54.8 lbs.
24"	EHD-24000	250 / Carton	59.6 lbs.

One (1) #3 Phillips BIT-PH3-2000 included per pkg.

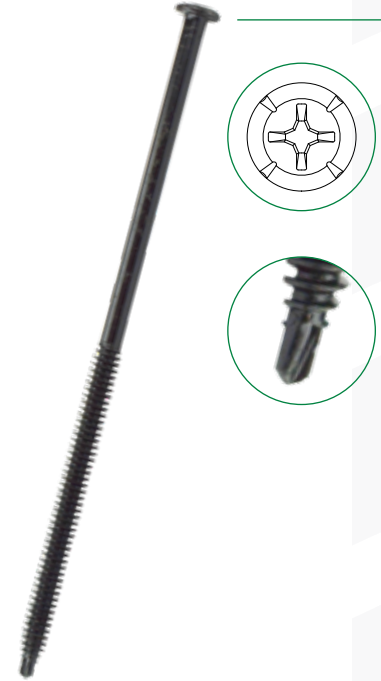

## EHD #15 Extra Heavy Duty Drill Point, #3 Phillips Truss Head, White E-coat

Length	Part No.	Pkg Qty/Type	Wgt/Pkg
2"	EHD-2000-W	1000 / Bucket	23.6 lbs.
3"	EHD-3000-W	1000 / Bucket	33.3 lbs.
4"	EHD-4000-W	1000 / Bucket	43.2 lbs.
5"	EHD-5000-W	1000 / Bucket	52.8 lbs.
6"	EHD-6000-W	500 / Bucket	31.8 lbs.
7"	EHD-7000-W	500 / Bucket	36.6 lbs.
8"	EHD-8000-W	500 / Bucket	41.4 lbs.
10"	EHD-10000-W	250 / Bucket	26.1 lbs.
12"	EHD-12000-W	250 / Bucket	30.9 lbs.

One (1) #3 Phillips BIT-PH3-2000 included per pkg.

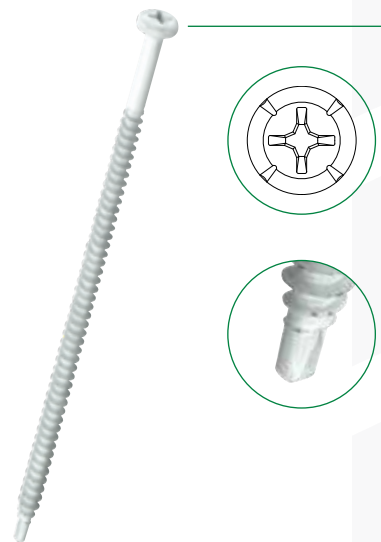

NOTE: TRUFAST does not warrant the cosmetic nature of the colored coatings applied to our mechanical fasteners. The colored surface of the coatings applied to the TRUFAST® fasteners will be impacted as the result of drilling into any deck substrates.



# ROOFING FASTENERS

The #12 Purlin Fastener is a self-drilling fastener engineered to secure single-ply roofing membrane to structural steel purlins (16 ga. to 3/16") in standing seam metal roof recover applications. The specially designed 3/4" long pilot point prevents the existing metal roof panel from "jacking" up the threads during the drilling operation, thereby reducing point burnout and breakage.

## PFC Purlin Fasteners, 1/4" Sq. Drive, Pancake Head, Black E-coat

Length	Part No.	Pkg Qty/Type	Wgt/Pkg
1-3/8"	PF-1375	2500 / Bucket	33.8 lbs.
2-3/4"	PF-2750	1000 / Bucket	23.7 lbs.
3-3/4"	PF-3750	1000 / Bucket	30.7 lbs.
4-3/4"	PF-4750	1000 / Bucket	38.1 lbs.
5-3/4"	PF-5750	1000 / Bucket	45.1 lbs.
6-3/4"	PF-6750	1000 / Bucket	52.1 lbs.
7-3/4"	PF-7750	500 / Bucket	30.1 lbs.
8-3/4"	PF-8750	500 / Bucket	32.9 lbs.
9-3/4"	PF-9750	500 / Bucket	35.3 lbs.

Two (2) #3 Square Driver Bits, BIT-S3-2000, included per pkg.



The Concrete Spike Fastener is a one-piece, vibration-resistant anchor designed to fasten insulation, single-ply roof membrane, wood, and steel to structural concrete roof decks. Featuring an "S" shaped configuration at the working end of the fastener to create an expansion mechanism, it provides a fast, reliable fastening solution for structural concrete roof applications.

## 1/4" Dia. Concrete Spike, Black E-coat

Length	Part No.	Pkg Qty/Type	Wgt/Pkg
1-1/4"	TS250-1250	500 / Bucket	11.2 lbs.
1-1/2"	TS250-1500	500 / Bucket	12.9 lbs.
2"	TS250-2000	500 / Bucket	16.8 lbs.
2-1/2"	TS250-2500	500 / Bucket	20.4 lbs.
3"	TS250-3000	500 / Bucket	23.9 lbs.
3-1/2"	TS250-3500	500 / Bucket	27.4 lbs.
4"	TS250-4000	500 / Bucket	30.9 lbs.
4-1/2"	TS250-4500	500 / Bucket	34.4 lbs.
5"	TS250-5000	500 / Bucket	38.0 lbs.
5-1/2"	TS250-5500	500 / Bucket	41.5 lbs.
6"	TS250-6000	250 / Bucket	23.1 lbs.
6-1/2"	TS250-6500	250 / Bucket	24.9 lbs.
7"	TS250-7000	250 / Bucket	26.6 lbs.
7-1/2"	TS250-7500	250 / Bucket	28.4 lbs.
8"	TS250-8000	250 / Bucket	30.1 lbs.
9"	TS250-9000	250 / Bucket	33.6 lbs.
10"	TS250-10000	250 / Bucket	37.1 lbs.
11"	TS250-11000	100 / Bucket	17.0 lbs.
12"	TS250-12000	100 / Bucket	18.4 lbs.
13"	TS250-13000	100 / Carton	19.7 lbs.
14"	TS250-14000	100 / Carton	21.1 lbs.
15"	TS250-15000	100 / Carton	22.3 lbs.
16"	TS250-16000	100 / Carton	23.6 lbs.

NOTE: Pre-drill hole using 1/4" dia. drill bit.



# ROOFING FASTENERS

TL Fasteners are designed to mechanically attach rigid insulation board and single-ply membrane to structural cement wood fiber, gypsum and lightweight insulating concrete roof decks. They feature a high thread profile with a tapered root diameter and sharp point. The unique design allows it to penetrate the roof deck and progressively compact the base material, creating a stronger hold in weak material. The TL Fastener is used in conjunction with the TRUFAST 2" TL Seam Plate and 3" TL Insulation Plate.

## TL Lightweight Nylon Fasteners

Length	Part No.	Pkg Qty/Type	Wgt/Pkg
2"	TL-2000	500 / Carton	11.0 lbs.
2-1/2"	TL-2500	500 / Carton	13.0 lbs.
3"	TL-3000	500 / Carton	15.0 lbs.
3-1/2"	TL-3500	500 / Carton	17.0 lbs.
4"	TL-4000	500 / Carton	18.0 lbs.
4-1/2"	TL-4500	500 / Carton	21.0 lbs.
5"	TL-5000	500 / Carton	22.0 lbs.
5-1/2"	TL-5500	500 / Carton	25.0 lbs.
6"	TL-6000	500 / Carton	27.0 lbs.
6-1/2"	TL-6500	500 / Carton	30.0 lbs.
7"	TL-7000	250 / Carton	16.0 lbs.
7-1/2"	TL-7500	250 / Carton	17.0 lbs.
8"	TL-8000	250 / Carton	17.5 lbs.
8-1/2"	TL-8500	250 / Carton	19.0 lbs.
9"	TL-9000	250 / Carton	20.0 lbs.
9-1/2"	TL-9500	250 / Carton	21.0 lbs.
10"	TL-10000	250 / Carton	22.0 lbs.
11"	TL-11000	250 / Carton	25.0 lbs.
12"	TL-12000	250 / Carton	26.0 lbs.
13"	TL-13000	250 / Carton	28.0 lbs.
14"	TL-14000	250 / Carton	29.0 lbs.

One (1) 1/4" Square Driver BIT-S250-1250 included per pkg.



## TL Plates

Size	Part No.	Pkg Qty/Type	Wgt/Pkg
2" Membrane	MPTL-2000	1000 / Carton	14.0 lbs.
3" Insulation	MPTL-3000	500 / Carton	17.5 lbs.



MPTL-2000



MPTL-3000

# 100 COUNT PACKAGES

Just needing a small quantity of fasteners or plates for a repair or small project? TRUFAST's fasteners (#12 DP & #14 HD) and plates (2" seam & 3" insulation) are available in convenient Patch Paks™ of 100 pieces each.



## DP #12 Drill Point, #3 Phillips Truss Head, Black E-coat

Length	Part No.	Pkg Qty/Type	Wgt/Master Carton
1-5/8"	DP-1625-100	100 / Carton	6.8 lbs.
2-1/4"	DP-2250-100	100 / Carton	8.6 lbs.
3"	DP-3000-100	100 / Carton	12.8 lbs.
4"	DP-4000-100	100 / Carton	15.0 lbs.
5"	DP-5000-100	100 / Carton	16.4 lbs.
6"	DP-6000-100	100 / Carton	19.2 lbs.

NOTE: Must be ordered in master cartons of 5 (500 pcs.)

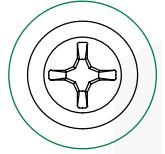

## HD #14 Heavy Duty Drill Point, #3 Phillips Truss Head, Black E-coat

Length	Part No.	Pkg Qty/Type	Wgt/Master Carton
1-1/2"	HD-1500-100	100 / Carton	7.7 lbs.
2"	HD-2000-100	100 / Carton	9.0 lbs.
2-1/2"	HD-2500-100	100 / Carton	9.5 lbs.
3"	HD-3000-100	100 / Carton	13.5 lbs.
3-1/2"	HD-3500-100	100 / Carton	12.0 lbs.
4"	HD-4000-100	100 / Carton	16.5 lbs.
4-1/2"	HD-4500-100	100 / Carton	17.0 lbs.
5"	HD-5000-100	100 / Carton	19.8 lbs.
5-1/2"	HD-5500-100	100 / Carton	20.5 lbs.
6"	HD-6000-100	100 / Carton	23.3 lbs.

NOTE: Must be ordered in master cartons of 5 (500 pcs.)

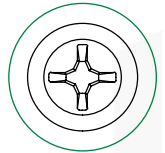

## Galvalume™ Plates

Description	Part No.	Pkg Qty/Type	Wgt/Master Carton
2" Galvalume™ (carton)	MP-2000-100	100 / Box	14.5 lbs.
3" Galvalume™	MP-3000-100	100 / Box	20.0 lbs.

NOTE: Must be ordered in master cartons of 10 (1,000 pcs.)



MP-2000



MP-3000

# STRESS PLATES & BATTEN BAR

TRUFAST Metal Seam Plates are used to mechanically attach single-ply and modified bituminous roof membranes to the substrate. The plate's circular design and reinforcing ribs provide exceptional strength to resist wind uplift forces. Metal Seam Plates are made of Galvalume coated steel for excellent corrosion protection that meet the requirements of ASTM D 6294, FM 4470 and DIN 50018.

TRUFAST Metal Insulation Plates are used to mechanically attach insulation, coverboards and BUR base sheets to the substrate. The plate's circular design and reinforcing ribs provide exceptional strength to resist wind uplift forces. TRUFAST Metal Insulation Plates are made of Galvalume coated steel for excellent corrosion protection that meet the requirements of ASTM D 6294, FM 4470 and DIN 50018.



MP-2000



MPB-2000



MPB-2400



MP-3000



MPR-3000

## Galvalume™ Plates

Size & Type	Part No.	Pkg Qty/Type	Wgt/Pkg	Qty/Skid (M)
2" Seam Plate	MP-2000	1000 / Bucket	27 lbs.	60
2" Barbed Seam Plate	MPB-2000	1000 / Bucket	28 lbs.	40
2.4" Barbed Seam Plate	MPB-2400	1000 / Bucket	52 lbs.	24
3" Insulation Plate	MP-3000	1000 / Bucket	34 lbs.	40
3" Recessed Insulation Plate	MPR-3000	1000 / Bucket	37 lbs.	40

NOTE: MP and MPB Plates are for use with Phillips Truss Head Fasteners and concrete spikes (TS).

TRUFAST® Batten Bars are used to mechanically attach roof membranes and flashings. The bar can be easily cut to any desired length. When installing, start at one end of the batten bar and fasten towards the other to reduce bowing between fasteners. Make sure all corners of cut bar are rounded. TRUFAST Batten Bars meet the corrosion resistance requirements of ASTM D 6294, FM Standard 4470 and DIN 50018.



BB-18F



BB-18R (RECESSED)

## Galvalume™ Seam/Batten Bar

Length	Part No.	Ft/Pkg/Type	Wgt/Pkg	Ft/Skid (M)
10'	BB-18F-6	500' / 3.5" Tube	85 lbs.	25
10'	BB-18R-6	500' / 3.5" Tube	85 lbs.	20

Punched 6" or 12" on center.



# INDUCTION WELDER, PLATES & ACCESSORIES

The TRUFAST® Induction Weld (IW) Plates are designed to attach insulation or coverboards to the deck while providing a non-penetrating mechanical attachment of single-ply membranes utilizing an induction welded bond to the TRUFAST IW Plate. Plates are available for use with TPO or PVC/KEE/TPA membranes. TRUFAST IW Plates are approximately 3-3/8" (85.4 mm) diameter. Plates are approved for use with steel, wood or structural concrete roof decks.



MPW-PVC-3375



MPW-TPO-3375



IWDISC-500

## Induction Weld Plates & Accessories

Size & Type	Part No.	Pkg Qty/Type	Wgt/Pkg	Qty/Skid (M)
3.375" PVC	MPW-PVC-3375	500 / Bucket	40.6 lbs.	20
3.375" TPO	MPW-TPO-3375	500 / Bucket	39.3 lbs.	20
4" Cardstock	IWDISC-500	500 / Box	8 lbs.	n/a

NOTE: IW Plates can be installed using #14 HD, #15 EHD and #12 Purlin.

## COMING SOON!

### TRUFAST INDUCTION WELDER

*A complete induction welding system — with welder, stand-up applicator, hand applicator, heat sinks, and more — will be available in 2024!*



# TERMINATION BAR & NAILINS

Termination Bar is used for edge or vertical parapet wall terminations.



TB-50



TB-90 & TB-125



TB-75 & TB-100

## Aluminum Termination Bar

Length	Part No.	Ft/Pkg/Type	Wgt/Pkg	Ft/Skid (M)	Punched O.C.
10'	TB-50	500' / 4" Tube	40 lbs.	20	6" or 8"
10'	TB-75	500' / 3.5" Tube	50 lbs.	25	6" or 8"
10'	TB-90	500' / 3.5" Tube	55 lbs.	25	6" or 8"
10'	TB-100	500' / 4" Tube	65 lbs.	20	6" or 8"
10'	TB-125	500' / 4" Tube	75 lbs.	20	6" or 8"

## Stainless Steel Bar

10'	TB-125-6-SS	200' / 3.5" Tube	98 lbs.	10	6"
10'	TB-75-6-SS	200' / 3.5" Tube	49 lbs.	10	6"

## Aluminum Gravel/Drain Bar

Length	Part No.	Ft/Pkg/Type	Wgt/Pkg	Ft/Skid (M)	Punched O.C.
10'	TB-100-RD	100' / 5" Tube	46 lbs.	2.6	6"



TB-100-RD

The ZAMAC Masonry Fastener is a nail-drive, general purpose anchor that can be used in concrete, block, brick, or stone. Applications include attachment of roof membrane terminations, roof flashing, and mechanical/electrical fixtures. It features an anchor body formed from a corrosion resistant ZAMAC alloy with a carbon steel drive nail. The mushroom head provides a tamper-proof installation.

## ZAMAC Masonry Fasteners

Size	Part No.	Pkg Qty/Type	Wgt/Master Ctn
3/16 x 7/8"	ZM187-0875-100	100 / Box	5.7 lbs.
1/4 x 1"	ZM250-1000-100	100 / Box	9.4 lbs.
1/4 x 1-1/4"	ZM250-1250-100	100 / Box	12.0 lbs.
1/4 x 1-1/2"	ZM250-1500-100	100 / Box	13.5 lbs.
1/4 x 2"	ZM250-2000-100	100 / Box	16.4 lbs.

NOTE: Sold in 100 count boxes. Master carton contains five (5) 100 count boxes (500 pcs.). Sold only in master cartons.

NOTE: Pre-drill a hole into the base material using the proper diameter drill bit that meets the requirements of ANSI Standard B212.15. The hole must be a minimum of 1/4" deeper than the required embedment.



# TOOLS & DRIVER BITS

TRUFAST offers a variety of tools to make installing fasteners easy and efficient. Driver bits are also included in most fastener packages for convenience.

## Pre-Assembled (PA) Tools & Shorty Tools

Description	Part No.	Qty/Carton	Wgt/Pkg
<b>Complete Tool</b> 29" Standup Tool & Electric Screw Gun	A-PA-CT	1	4.0 lbs.
<b>Upper Body Assembly</b> 29" Standup Tool Only (Assembly includes everything needed <b>except</b> Milwaukee Model 6792-20 Screw Gun)	A-PA-UBA	1	1.0 lbs.
<b>Lower Body Assembly Replacement Part</b>	A-PA-LBA	1	1.0 lbs.
<b>20" Drive Shaft Replacement Part</b>	A-PA-20-DS	1	1.2 lbs.
<b>PA Bag</b>	A-PA-BAG	1	1.0 lbs.
<b>PA Bag &amp; Setter Tool Combo</b>	A-PA-SBC	1	1.0 lbs.
<b>Shorty Attachment Tool</b>	A-PA-ST	1	1.4 lbs.
<b>SIP Shorty Attachment Tool</b>	A-PA-SST	1	1.4 lbs.

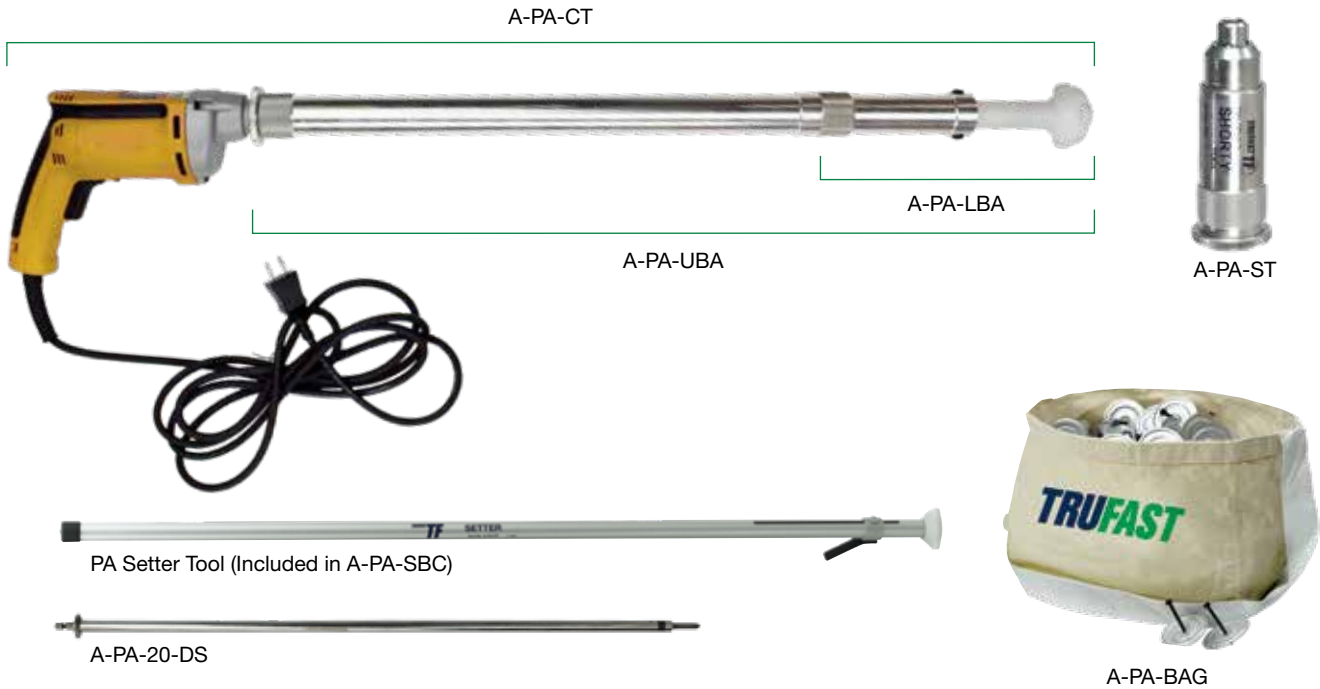

## Driver Bits

Description	For Use With	Part No.
#2 Phillips x 2" Driver Bit	#2 Phillips Head Fasteners	BIT-PH2-2000
#3 Phillips x 2" Driver Bit	#3 Phillips Head Fasteners	BIT-PH3-2000
#3 Square x 2" Driver Bit	Purlin Fastener	BIT-S3-2000
1/4" x 2" Hex Head Nutsetter	DPH	BIT-H250-1750
T-30 6-Lobe Driver Bit	SIPTP, SIPLD, SIPHD	BIT-T30-2000



# SIP FASTENERS

TRUFAST® SIP Fasteners are specifically engineered for attaching structural insulated panels (SIPs) and nail base panels to wood and metal framing. Featuring a large, pancake head style with a 6-lobe drive, TRUFAST SIP Fasteners drive quickly and smoothly, and draw panels securely without the need of a washer.

## SIPTP (Thread Point)

For wood and timber applications.



## SIPLD (Light-duty Drill Point)

For corrugated steel decks and wood applications.

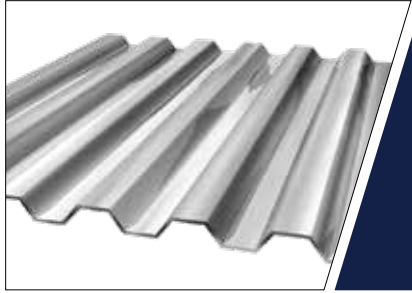

## SIPHD (Heavy-duty Drill Point)

For structural steel members (up to 3/16" thick without pre-drilling).



## SIPTP Structural Insulated Panel Fasteners, Thread Point

Pancake Head with T-30 6-Lobe Drive, Black E-coat

Length	Part No.	Pkg Qty/Type	Wgt/Pkg
2"	SIPTP-2000	500 / Bucket	12.4 lbs.
2-1/2"	SIPTP-2500	500 / Bucket	14.4 lbs.
3"	SIPTP-3000	500 / Bucket	16.4 lbs.
3-1/2"	SIPTP-3500	500 / Bucket	18.4 lbs.
4"	SIPTP-4000	500 / Bucket	20.7 lbs.
4-1/2"	SIPTP-4500	500 / Bucket	22.7 lbs.
5"	SIPTP-5000	500 / Bucket	25.0 lbs.
5-1/2"	SIPTP-5500	500 / Bucket	27.0 lbs.
6"	SIPTP-6000	500 / Bucket	29.0 lbs.
6-1/2"	SIPTP-6500	500 / Bucket	29.8 lbs.
7"	SIPTP-7000	500 / Bucket	31.9 lbs.
7-1/2"	SIPTP-7500	500 / Bucket	34.0 lbs.
8"	SIPTP-8000	500 / Bucket	36.4 lbs.
8-1/2"	SIPTP-8500	250 / Bucket	19.5 lbs.
9"	SIPTP-9000	250 / Bucket	20.5 lbs.
10"	SIPTP-10000	250 / Bucket	22.5 lbs.
11"	SIPTP-11000	250 / Bucket	24.4 lbs.
12"	SIPTP-12000	250 / Bucket	27.3 lbs.
13"	SIPTP-13000	250 / Carton	29.2 lbs.
14"	SIPTP-14000	250 / Carton	31.2 lbs.
15"	SIPTP-15000	250 / Carton	33.2 lbs.
16"	SIPTP-16000	250 / Carton	35.2 lbs.

NOTE: Two (2) T-30 6-Lobe Driver Bits, BIT-T30-2000, included in each package. SIPTP Fasteners are designed for attaching panels to wood.

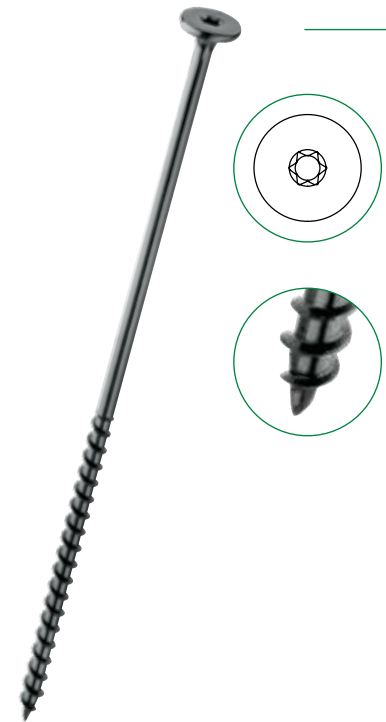



# SIP FASTENERS

## SIPLD Structural Insulated Panel Fasteners, Light-duty #2 Drill Point Pancake Head with T-30 6-Lobe Drive, Black E-coat

Length	Part No.	Pkg Qty/Type	Wgt/Pkg
3"	SIPLD-3000	500 / Bucket	15.2 lbs.
3-1/2"	SIPLD-3500	500 / Bucket	17.4 lbs.
4"	SIPLD-4000	500 / Bucket	19.7 lbs.
4-1/2"	SIPLD-4500	500 / Bucket	21.9 lbs.
5"	SIPLD-5000	500 / Bucket	24.1 lbs.
5-1/2"	SIPLD-5500	500 / Bucket	26.0 lbs.
6"	SIPLD-6000	500 / Bucket	27.9 lbs.
6-1/2"	SIPLD-6500	500 / Bucket	29.8 lbs.
7"	SIPLD-7000	500 / Bucket	31.9 lbs.
7-1/2"	SIPLD-7500	500 / Bucket	33.8 lbs.
8"	SIPLD-8000	500 / Bucket	35.5 lbs.
8-1/2"	SIPLD-8500	250 / Bucket	20.2 lbs.
9"	SIPLD-9000	250 / Bucket	20.2 lbs.
9-1/2"	SIPLD-9500	250 / Bucket	21.2 lbs.
10"	SIPLD-10000	250 / Bucket	22.3 lbs.
11"	SIPLD-11000	250 / Bucket	24.0 lbs.
12"	SIPLD-12000	250 / Bucket	26.2 lbs.
13"	SIPLD-13000	250 / Carton	28.1 lbs.
14"	SIPLD-14000	250 / Carton	30.1 lbs.
15"	SIPLD-15000	250 / Carton	32.1 lbs.
16"	SIPLD-16000	250 / Carton	34.3 lbs.
18"	SIPLD-18000	250 / Carton	38.1 lbs.

NOTE: Two (2) T-30 Driver Bits included in each package.  
SIPLD Fasteners are designed for attaching panels to wood and 22 - 18 ga. corrugated steel decks.

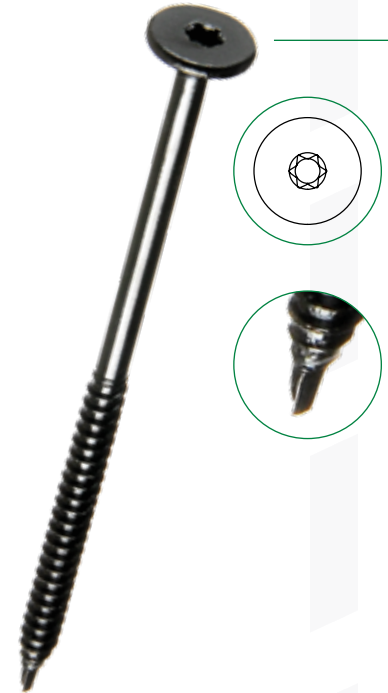

## SIPHD Structural Insulated Panel Fasteners, Heavy-duty #4 Drill Point Pancake Head with T-30 6-Lobe Drive, Black E-coat

Length	Part No.	Pkg Qty/Type	Wgt/Pkg
4-1/2"	SIPHD-4500*	500 / Bucket	22.5 lbs.
6"	SIPHD-6000	500 / Bucket	34.8 lbs.
8"	SIPHD-8000	250 / Bucket	23.1 lbs.
9-3/4"	SIPHD-9750	250 / Bucket	27.0 lbs.
11-3/4"	SIPHD-11750	250 / Bucket	31.2 lbs.
13-3/4"	SIPHD-13750	250 / Carton	36.7 lbs.

NOTE: Two (2) T-30 Driver Bits included in each package.  
SIPHD Fasteners are designed for attaching panels to 16 ga. - 3/16" steel members without pre-drilling.  
\*SIPHD-4500 is #12 diameter.



# BASE SHEET FASTENERS & ACCESSORIES

Twin Loc-Nails and FM Series fasteners are for base sheet, recovery board, and insulation attachment to lightweight insulating concrete, structural wood fiber, and poured gypsum.

## Twin Loc-Nails

For base sheet and insulation attachment to lightweight insulating concrete, cementitious wood fiber (Tectum®) and poured gypsum roof decks.

Part/Length	Part No.	Qty/Carton	Carton Wgt.	Qty/Skid
Twin Loc-Nail, 1.4" (35.6 mm)	TWL-1400	500	24.6 lbs.	15,000
Twin Loc-Nail, 1.8" (45.7 mm)	TWL-1800	500	26.8 lbs.	15,000
Twin Loc-Nail, 2.8" (71.1 mm)	TWL-2800	500	33.7 lbs.	15,000
Twin Loc-Nail, 3.8" (96.5 mm)	TWL-3800	500	39.2 lbs.	15,000
Twin Loc-Nail, 4.8" (121.9 mm)	TWL-4800	250	24.1 lbs.	7,500



TWL-1800

## FM Series Fastener / Disk Units

For base sheet attachment to lightweight insulating concrete and poured gypsum roof decks.

Part/Length	Part No.	Qty/Carton	Carton Wgt.	Qty/Skid
FM-90, 1.7"	FM-90-1700	1,000	39.2 lbs.	18,000
FM-75, 1.2"	FM-75-1200	1,000	34.5 lbs.	18,000



FM-90

## Tools & Accessories

Item	Part No.	Wgt.
Twin Loc Driver	A-ES-TWL	6.0 lbs.
Twin Loc Insulation Driver	A-ES-IND	7.0 lbs.

Always use a Twin Loc Driver when attaching the base sheet using a 1.4, 1.8 Twin Loc and FM-75, FM-90 base sheet fasteners. Use the Twin Loc Insulation Driver (has a 5" diameter plate) when attaching insulation using 2.8", 3.8" or 4.8" Twin Loc-Nail Base Sheet Fasteners.

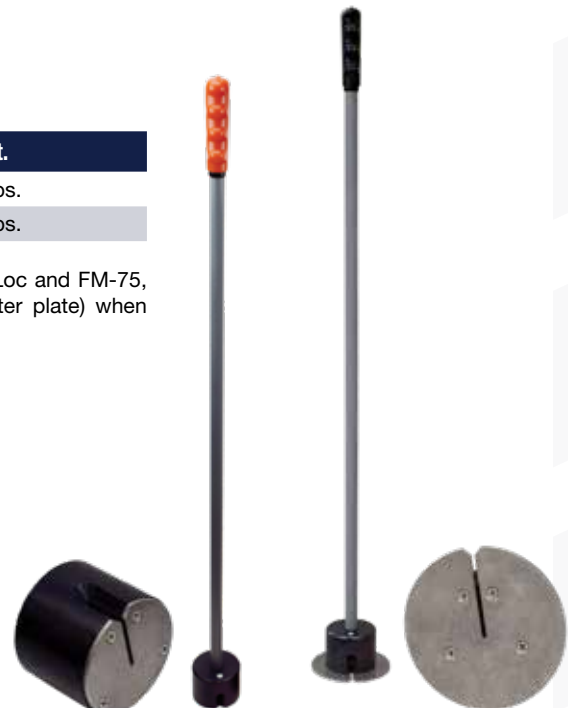

Twin Loc Driver

Twin Loc Insulation Driver

# VERSA-FAST® FASTENERS & PLATES

VERSA-FAST® Fasteners are engineered to secure insulation, coverboard and base sheets to light weight insulating concrete and gypsum decks. The VERSA-FAST Fastener features an exclusive thread design engineered for exceptional pull out resistance. When used in conjunction with the VERSA-FAST Metal Plate, multiple fasteners can be installed to achieve the required minimum pull out. Patent No. 10,190,616.

## VERSA-FAST® Fasteners

Length	Part No.	Pkg Qty/Type	Wgt/Pkg
2-1/4"	VF-2250	1000 / Bucket	16.0 lbs.
3-1/4"	VF-3250	1000 / Bucket	20.2 lbs.
4-1/4"	VF-4250	1000 / Bucket	24.4 lbs.
5-1/4"	VF-5250	1000 / Bucket	28.6 lbs.
6-1/4"	VF-6250	1000 / Bucket	32.8 lbs.

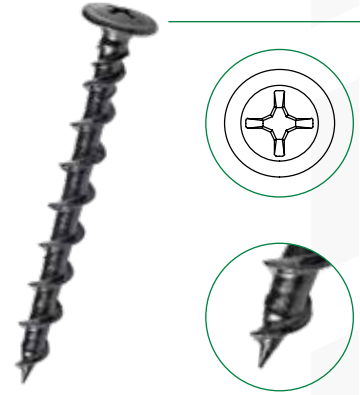

VERSA-FAST® Metal Plates are used to mechanically attach insulation, cover boards and base sheets to light weight insulation concrete (LWIC) and gypsum decks. The VERSA-FAST Metal Plate is a circular design with one center fastener placement hole and eight equally spaced fastener placement holes around the perimeter of the plate allowing for maximum versatility. Required pullout values can be achieved by installing multiple VERSA-FAST Fasteners in one VERSA-FAST Metal Plate.

## VERSA-FAST® Metal Plates

Size	Part No.	Pkg Qty/Type	Wgt/Pkg
3" Membrane	MPVF-3000	1000 / Bucket	32.0 lbs.

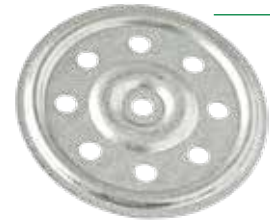

# ADHESIVES & SEALANTS

TRUFAST® Roofing Adhesive is a construction-grade, polyurethane foam adhesives designed to adhere to approved roof insulations, thermal barriers, cover boards and fleece backed membranes to acceptable substrates. It is available in cartridges, pressurized tanks, or drums.

## TRUFAST® Low-Rise Roofing Adhesive

	Part No.	Description
Pressure Tanks	TRA-PRT-O-A50	<b>TRUFAST® Low-Rise Roofing Adhesive "A" Pressurized Tank</b> (A includes: 25' Gun Hose Assembly, Wrench & 10 Long Cone Nozzles, Petroleum Jelly)
	TRA-PRT-O-B50	<b>TRUFAST® Low-Rise Roofing Adhesive "B" Pressurized Tank</b>
	TRA-PRT-25GHA	25' Gun Assembly with Hose
	TRA-PRT-10LCONE	10 Static Mixers, 10 Shower Cap Tips, Petroleum Jelly Packet, 1 Push-to-Connect Manifold, 1 NOX Valve, Instruction Sheet
Cartridges	TRA-CTR-1500	<b>TRUFAST® Low-Rise Roofing Adhesive Cartridge</b> (4) 1,500 ML Cartridge Box W/6 Static Mix Tips; 19 lbs/case — 54 cases/pallet
	TRA-CTR-BOD	Battery Operated Dispenser for Roof Adhesive 1500 ML Cartridge (1 per box)
	TRA-CTR-SMT	TRUFAST® Cartridge Static Mix Tips (10-Pack)
Pony Kegs	TRA-PK-A15	<b>TRUFAST® Low-Rise Adhesive - 15 Gallon Pony Keg "A"</b>
	TRA-PK-B15	<b>TRUFAST® Low-Rise Adhesive - 15 Gallon Pony Keg "B"</b>
Drums*	TRA-DRM-A500	<b>TRUFAST® Low-Rise Adhesive - 50 Gallon Drum "A"</b> *
	TRA-DRM-B500	<b>TRUFAST® Low-Rise Adhesive - 50 Gallon Drum "B"</b> *

\*The Drum Sets are not stocked, please allow 3 weeks + transit for delivery. Non-returnable.





# ADHESIVES & SEALANTS

## DuPont® INSTA STIK™ Quik Set Commercial Roofing Adhesive

DuPont® INSTA STIK™ Quik Set is a single-component polyurethane adhesive designed to attach compatible roof insulation boards to roof decks and substrates in new roof and replacement applications.

### Product Features

- Dispensed from a portable, pre-pressurized container (30 lb. unit / 23 lb. net chemical) requiring no external power source.
- Yield: 8 to 9 squares per tank (at 3/4" to 1" bead size and 12" o.c. spacing).
- 15 month shelf life.
- 3 to 6 minute tack time and approximately 4 hour cure time (depending on humidity).
- Approved for use on concrete, Tectum™ (cementitious wood fiberboard), wood, tapered systems, and multi-level insulation.
- FM, UL, and Miami-Dade Approvals.
- 10 to 20 year warranties available; must submit Dow Job Qualification Form.

## DuPont® FROTH-PAK™ Spray Polyurethane Foam Sealant

DuPont® FROTH-PAK™ Foam Sealant is a two-component, quick-cure spray polyurethane foam that fills cavities, penetrations, cracks and expansion joints. FROTH-PAK™ Foam is chemically cured, significantly reducing curing time. It dispenses, expands, and becomes tack-free in seconds and completely cures in minutes.

**Yield: Approx. 200 board feet or 16.6 cubic feet per kit.**

## DuPont® TILE BOND

Packaged in a self-contained disposable can or canister, TILE BOND™ is a portable one-component polyurethane foam roof tile adhesive for attaching concrete and clay roof tiles. It is quicker and easier to install compared to traditional attachment methods such as screws, mortar, wire ties and clips. Minimal expanding TILE BOND™ also provides greater attachment strength while minimizing nail penetrations and reducing roof weight loads. With its easy-to-use dispensing equipment, TILE BOND™ can be quickly and efficiently dispensed in a highly consistent manner, eliminating the need for expensive equipment and ratio monitoring.

## DuPont® Adhesives & Sealants

	Part No.	Description
INSTA STIK	DOW-308916	<b>INSTA STIK Quik Set Commercial Roofing Adhesive – Tank Only</b> (31 lbs/tank – 40 tanks/pallet; Instructions included in each carton)
	DOW-IS1D	<b>Hose &amp; Wand Dispensing Kit</b> Kit includes 4' hose, on/off valve, 2-pc. wand, coupler, and wrench NOTE: Approximately 3 tanks per kit.
FROTH-PAK	DOW-12031949	<b>FROTH-PAK 200 Kit (1.75 pcf) Spray Polyurethane Foam Sealant</b> 31 lbs/kit – 26 kits/pallet; Instructions included in each carton; Kit includes 1 ea. A and B components, 1 gun/hose assy., 6 cone spray and 4 fan spray nozzles
	DOW-12030877	<b>Cone Spray Nozzle – Low Output (green / white back)</b> Pack of 25 nozzles
	DOW-12031375	<b>GHA 15' Gun &amp; Hose Assembly</b> Includes 1 dispensing gun, 2 chemical hoses, 5 gram lubricating packet, 8 cone spray and 4 fan spray nozzles
TILE BOND	DOW-308276	<b>TILE BOND (Complete Kit)</b> 23 lbs/kit – 40 kits/pallet Kit includes: Hose, dispenser, coupler, valve, wrench, and instructions (12 month shelf life)
	DOW-308941	<b>TILE BOND (28 oz. Cans)</b> 28 lbs/case – 12 cans/case – 64 cases/pallet (12 month shelf life)
	DOW-235597	<b>Gun/Hose Assembly</b>

# ROOFTOP DRAINS

MADE IN USA

TRUFast® Rooftop Drains can be an essential part of your roofing system. Making sure your application has the right drain to handle typical rainfall amounts is crucial to the life of a commercial roof. Drains come in a variety of materials and sizes to meet your application needs.

## EasySeal™ Aluminum Retrofit Drains (with Mechanical Seal)

Part No.	Size	Clamping Ring	Strainer	Pkg. Wt.	Qty/Pallet
RD-BALUM3CRP	3"	Aluminum	10" Aluminum	8 lbs.	36
RD-BALUM4CRP	4"	Aluminum	10" Aluminum	8 lbs.	36
RD-BALUM5CRP	5"	Aluminum	10" Aluminum	8 lbs.	36
RD-BALUM6CRP	6"	Aluminum	10" Aluminum	8 lbs.	36

### Available Accessories

Part No.	Description	Pkg. Wt.
RD-BS-1030TPO	TPO Flange Coating	N/A
RD-BS-1030	PVC Flange Coating	N/A



TPO Coating



PVC Coating

## “ALL” Aluminum Retrofit Drains (with Sealant Tape)

Part No.	Size	Clamping Ring	Strainer	Pkg. Wt.	Qty/Pallet
RD-2000-AL-ASCR	2"	Aluminum	10" Aluminum	7 lbs.	36
RD-3000-AL-ASCR	3"	Aluminum	10" Aluminum	7 lbs.	36
RD-4000-AL-ASCR	4"	Aluminum	10" Aluminum	7 lbs.	36
RD-6000-AL-ASCR	6"	Aluminum	10" Aluminum	8 lbs.	36

### Available Upgrades

Part No.	Description	Pkg. Wt.
RD-BS-1030TPO	TPO Flange Coating	N/A
RD-BS-1030	PVC Flange Coating	N/A



TPO Coating



PVC Coating

# ROOFTOP DRAINS

## Aluminum Retrofit Drains (with Sealant Tape & PVC Strainer)

Part No.	Size	Clamping Ring	Strainer	Pkg. Wt.	Qty/Pallet
RD-2000-AL	2"	Composite	10" Plastic	4 lbs.	36
RD-3000-AL	3"	Composite	10" Plastic	4 lbs.	36
RD-4000-AL	4"	Composite	10" Plastic	4 lbs.	36
RD-6000-AL	6"	Composite	10" Plastic	6 lbs.	36

NOTE: Available in pallet quantities only.

### Available Upgrades

Part No.	Description	Pkg. Wt.
RD-10000-CI-S	10" Cast Iron Strainer	7 lbs.
RD-10000-CI-SCR	10" Cast Iron Strainer & Clamping Ring	8.25 lbs.
RD-10000-AL-SCR	10" Aluminum Strainer & Clamping Ring	4 lbs.
RD-BS-1030TPO	TPO Flange Coating	N/A
RD-BS-1030	PVC Flange Coating	N/A



TPO Coating



PVC Coating

## Copper Retrofit Drains (with Sealant Tape & PVC Strainer)

Part No.	Size	Clamping Ring	Strainer	Pkg. Wt.	Qty/Pallet
RD-3000-CU	3"	Composite	10" Plastic	4 lbs.	36
RD-4000-CU	4"	Composite	10" Plastic	4 lbs.	36
RD-6000-CU	6"	Composite	10" Plastic	9 lbs.	16

NOTE: Available in pallet quantities only.

### Available Upgrades

Part No.	Description	Pkg. Wt.
RD-10000-CI-S	10" Cast Iron Strainer	7 lbs.
RD-10000-CI-SCR	10" Cast Iron Strainer & Clamping Ring	8.25 lbs.
RD-10000-AL-SCR	10" Aluminum Strainer & Clamping Ring	4 lbs.
RD-BS-1030TPO	TPO Flange Coating	N/A
RD-BS-1030	PVC Flange Coating	N/A



TPO Coating



PVC Coating



Cast Iron Strainer



Clamping Ring



Aluminum Strainer

# ROOFTOP DRAINS

## PVC New Installation Drain Kit (with PVC Strainer)

Part No.	Size	Clamping Ring	Strainer	Pkg. Wt.	Qty/Pallet
RD-3000-PVC	3"	Aluminum	10" Plastic	8 lbs.	63
RD-4000-PVC	4"	Aluminum	10" Plastic	8 lbs.	63
RD-6000-PVC	6"	Aluminum	10" Plastic	15 lbs.	63

NOTE: Available in pallet quantities only.

### Available Upgrades

Part No.	Description	Pkg. Wt.
RD-10000-CI-S	10" Cast Iron Strainer	7 lbs.
RD-10000-AL-S	10" Aluminum Strainer	2 lbs.
RD-12000-CI-S	12" Cast Iron Strainer	11 lbs.



## Cast Iron New Installation Drain Kit (with PVC Strainer)

Part No.	Size	Clamping Ring	Strainer	Pkg. Wt.	Qty/Pallet
RD-3000-CI	3"	Aluminum	10" Cast Iron	14 lbs.	63
RD-4000-CI	4"	Aluminum	10" Cast Iron	15 lbs.	63
RD-6000-CI	6"	Cast Iron	10" Cast Iron	36 lbs.	20

NOTE: Available in pallet quantities only.

### Available Upgrades

Part No.	Description	Pkg. Wt.
RD-10000-AL-S	10" Aluminum Strainer	2 lbs.
RD-12000-CI-S	12" Cast Iron Strainer	11 lbs.



Cast Iron Strainer



Aluminum Strainer

## PVC New Installation Drain Kit (with Aluminum Strainer)

Part No.	Size	Clamping Ring	Strainer	Pkg. Wt.	Qty/Pallet
RD-3000-PVC-A	3"	Aluminum	10" Aluminum	11 lbs.	63
RD-4000-PVC-A	4"	Aluminum	10" Aluminum	11 lbs.	63
RD-6000-PVC-A	6"	Aluminum	10" Aluminum	15 lbs.	63



## Aluminum Economy Insert Drain

Part No.	Size	Pkg. Wt.	Qty/Pallet
RD-BFF175ECO	2"	4 lbs. / ea.	40
RD-BFF275ECO	3"	4 lbs. / ea.	40
RD-BFF375ECO	4"	4 lbs. / ea.	40

NOTE: Available in pallet quantities only. Packing is loose bulk pack. Sizes may be combined to achieve pallet quantity.





# THE TRUFAST COMMITMENT

## PRODUCT WHEN YOU NEED IT

The expansion of our manufacturing facility completed in 2018 doubled our fastener capacity! You can get TRUFAST® products when and where you need them with four regional warehouse locations:

- Bryan, Ohio
- Grand Prairie, Texas
- Orlando, Florida
- Ontario, California

## INDUSTRY CODE APPROVALS

Independent testing and certification assures our customers that TRUFAST fasteners have been objectively tested and conform to the highest national and international standards. TRUFAST fasteners and accessories are evaluated, recognized and listed by FM Global, Miami-Dade County Product Control, State of Florida, DrJ Certification, European Technical Approvals and NTA, Inc., providing architects, specifiers, contractors and building code officials with evidence that our products meet these building code requirements.

## SUPERIOR CUSTOMER SERVICE

We can tell you all about our amazing customer service, but we'll let you hear from our customers instead:

*"Great supplier! From shipping and customer care to technical services and performance."*

Arlington Heights, IL

*"The people at TRUFAST are always quick to respond and are great to work with."*

Portland, ME

*"Best partner we have is TRUFAST."*

Saginaw, MI

## FIELD SERVICES

We go the extra mile for you with field services including in-field product training and demonstrations, on-site pull tests and the support of dozens of experienced field reps across the country.

## ENGINEERING AND TECHNICAL SERVICES

The TRUFAST Engineering & Technical Services team consists of highly experienced engineers and technicians in the fields of metallurgy, corrosion resistance, wind uplift testing and building code compliance. Our advanced Engineering Tech Center enables us to conduct sophisticated testing to ensure that TRUFAST products are designed and manufactured to the quality and performance standards that our customers depend on.

TRUFAST also actively collaborates with many of the leading manufacturers and suppliers in the commercial roofing and building materials industries to design and develop innovative, code-compliant fastening solutions.

## QUALITY PRODUCTS

Quality is always our first commitment. We are ISO 9001:2008 certified, and our products go through rigorous quality control checks at every step in the manufacturing process — assuring you of the highest quality.

## YOUR SATISFACTION GUARANTEED

Our commitment to customer satisfaction is simple: we do what we say we'll do. And if there's ever a concern, we always make it right.

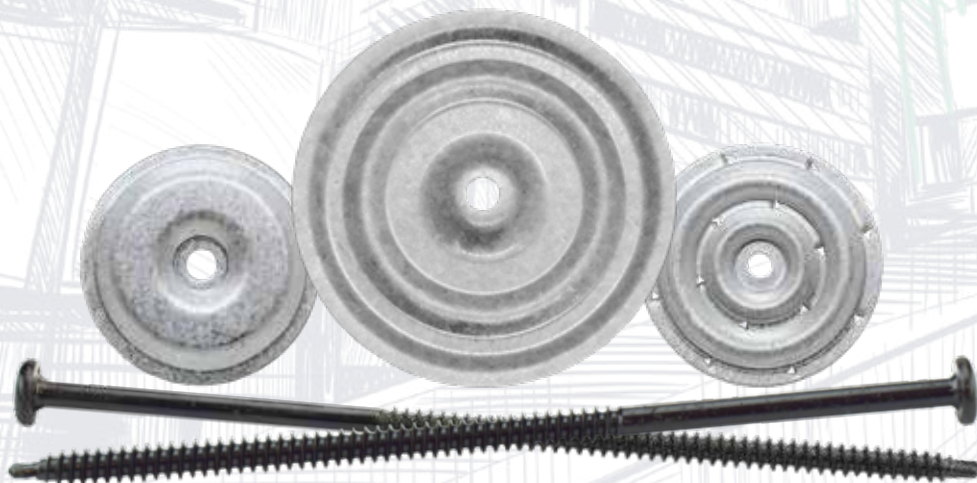















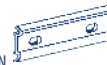



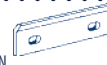





FIJADORES	APLICACIONES	HILOS POR PULG./DISEÑO	DISEÑO DE CABEZA	UTILIZAR CON	LONGITUDES ESTÁNDARES	MATERIAL/ACABADO	CÓDIGOS APROBADOS
<p>TORNILLOS PARA TECHO DP #12</p>	ACERO (CALIBRE 16 ó MÁS DELGADO)	13 DE AVANCE SENCILLO	PHILLIPS #3 CABEZA PLANA REDONDA	CHAPA METÁLICA	1-5/8", 2-1/4", 3", 4", 5", 6", 7", 8"	ACERO AL CARBONO E-COAT NEGRA	FM, MIAMI-DADE CE - ETA 19/0616 Estado de Florida - FL#: 4500
<p>TORNILLOS PARA TECHO HD #14</p>	ACERO (CALIBRE 16 - 24), MADERO, O CONCRETO	13 DE AVANCE SENCILLO	PHILLIPS #3 CABEZA PLANA REDONDA	CHAPA METÁLICA LISTÓN	1-1/4", 1-1/2", 2", 2-1/2", 3", 3-1/2", 4", 4-1/2", 5", 5-1/2", 6", 7", 8", 9", 10", 11", 12"	ACERO AL CARBONO E-COAT NEGRA	FM, MIAMI-DADE CE - ETA 19/0616 Estado de Florida - FL#: 4500
<p>TORNILLOS EN ACERO INOXIDABLE PARA TECHO HD #14</p>	ACERO (CALIBRE 18 ó MÁS DELGADO) O MADERA	13 DE AVANCE SENCILLO	PHILLIPS #3 CABEZA PLANA REDONDA	CHAPA METÁLICA LISTÓN	1-1/2", 2", 3", 4", 5", 6", 7", 8", 9", 10", 12"	ACERO INOXIDABLE 316	FM, MIAMI-DADE CE - ETA 19/0616 Estado de Florida - FL#: 4500
<p>TORNILLOS PARA TECHO EHD #15</p>	ACERO (CALIBRE 18 ó MÁS DELGADO) O MADERA	13 DE AVANCE SENCILLO CONTRAFUERTE	PHILLIPS #3 CABEZA PLANA REDONDA	CHAPA METÁLICA LISTÓN	2", 3", 4", 5", 6", 7", 8", 9", 10", 11", 12", 14", 16", 18", 20", 22", 24"	ACERO AL CARBONO E-COAT NEGRA	FM, MIAMI-DADE CE - ETA 19/0616 Estado de Florida - FL#: 4500
<p>PRE ENSAMBLADO (PA)</p>	ACERO (CALIBRE 16 ó MÁS DELGADO) O MADERA	13 DE AVANCE SENCILLO	PHILLIPS #3 CABEZA PLANA REDONDA	CHAPA METÁLICA	1-5/8", 2-1/4", 2-7/8", 3-1/4", 3-3/4", 4-1/2", 5", 6", 7", 8"	TORNILLO DE ACERO AL CARBONO/E-COAT NEGRA; ARANDELA EN GALVALUME®	FM Estado de Florida - FL#: 4500 MIAMI-DADE
<p>TORNILLOS PARA TECHO CON TIRAFONDO PARA CONCRETO 1/4"</p>	CONCRETO	N/A	CABEZA REDONDA	CHAPA METÁLICA LISTÓN	1-1/4", 1-1/2", 2", 2-1/2", 3", 3-1/2", 4", 4-1/2", 5-1/2", 6", 6-1/2", 7", 7-1/2", 8", 9", 10", 11", 12", 13", 14", 15", 16"	ACERO AL CARBONO E-COAT NEGRA	FM
<p>TORNILLOS PARA TECHO TL</p>	TECTUM® Y CONCRETO LIVIANO	RAÍZ CÓNICA CON CONTRAFUERTE	CABEZA PLANA CON CUADRADO INTERIOR 1/4"	CHAPA METÁLICA	2", 2-1/2", 3", 3-1/2", 4", 4-1/2", 5", 5-1/2", 6", 6-1/2", 7", 7-1/2", 8", 8-1/2", 9", 9-1/2", 10", 11", 12", 13", 14"	NYLON	FM MIAMI-DADE Estado de Florida - FL#: 4500
<p>TONILLOS VERSA-FAST®</p>	CONCRETO LIVIANO Y YESO	4 DE AVANCE SENCILLO	PHILLIPS #2	VERSA-FAST® CHAPA METÁLICA	2-1/4", 3-1/4", 4-1/4", 5-1/4", 6-1/4"	ACERO AL CARBONO E-COAT NEGRA	FM MIAMI-DADE Estado de Florida - FL#: 4500
<p>TORNILLOS PARA TECHO CON VIGUETAS #12</p>	ACERO (3/16" DE ESPESOR O MÁS DELGADO)	24 DE AVANCE SENCILLO	CABEZA DE PANCAKE CON CUADRADO INTERIOR #3	CHAPA METÁLICA LISTÓN	1-3/8", 2-3/4", 3-3/4", 4-3/4", 5-3/4", 6-3/4", 7-3/4", 8-3/4", 9-3/4"	ACERO AL CARBONO E-COAT NEGRA	FM, MIAMI-DADE CE - ETA 19/0616 Estado de Florida - FL#: 4500
<p>TORNILLO SIP LD</p>	ACERO CORRUGADO, MADERA, Y CONCRETO	10 DE AVANCE SENCILLO	CABEZA DE PANCAKE T-STAR #30	N/A	2-1/4", 3", 3-1/4", 3-1/2", 4", 4-1/4", 4-1/2", 5", 5-1/2", 6", 6-1/2", 7", 7-1/2", 8", 8-1/2", 9", 9-1/2", 10", 11", 12", 13", 14", 15", 16", 17", 18"	ACERO AL CARBONO E-COAT NEGRA	FM, MIAMI-DADE CE - ETA 19/0616 Estado de Florida - FL#: 4500
<p>TORNILLO SIP HD</p>	ACERO ESTRUCTURAL	20 DE AVANCE SENCILLO	CABEZA DE PANCAKE T-STAR #30	N/A	2-1/4", 3-1/4", 4-1/4", 5-1/4", 6", 8", 9-3/4", 11-3/4", 13-3/4"	ACERO AL CARBONO E-COAT NEGRA	FM, MIAMI-DADE CE - ETA 19/0616 Estado de Florida - FL#: 4500
<p>TORNILLO SIP TP</p>	MADERA	7 DE AVANCE SENCILLO	CABEZA DE PANCAKE T-STAR #30	N/A	2", 2-1/2", 3", 3-1/2", 4", 4-1/2", 5", 5-1/2", 6", 6-1/2", 7", 7-1/2", 8", 8-1/2", 9", 10", 11", 12", 13", 14", 15", 16", 17"	ACERO AL CARBONO E-COAT NEGRA	FM, MIAMI-DADE CE - ETA 19/0616 Estado de Florida - FL#: 4500



TORNILLOS PARA BASE DE LÁMINA	APLICACIONES	LONGITUDES ESTÁNDARES	DIÁMETRO CABEZA / DISCO	MATERIAL / ACABADO	CÓDIGOS APROBADOS
TWIN LOC-NAIL 	AISLAMIENTO EN CONCRETO LIVIANO, TECTUM® & YESO	1.4", 1.8"	2.7"	GALVALUME® - ARANDELA, ACERO RECUBIERTO - TUBO EN ACERO INOXIDABLE - GRAPA DE BLOQUEO	FM MIAMI-DADE
FM 	AISLAMIENTO EN CONCRETO LIVIANO & YESO	FM-75 - 1.2" FM-90 - 1.7"	2.7"	GALVALUME® - ARANDELA EN POLÍMERO CON ACERO RECUBIERTO - PATAS	FM MIAMI-DADE

ARANDELAS	APLICACIONES	UTILIZAR CON	CÓDIGOS APROBADOS	BARRAS	CARACTERÍSTICA	ESPESOR	MATERIAL	CÓDIGOS APROBADOS
ARANDELA METÁLICA PARA AISLAMIENTO 3" 	PANELES CUBIERTAS, AISLAMIENTO Y TALADRAR LA BASE DE LA LÁMINA AL SUSTRATO	DP, HD, HD-SS, EHD, TS250	FM, MIAMI-DADE CE - ETA 19/0616 Estado de Florida - FL#: 4500	TB-50 BARRA DE TERMINACIÓN 	REBORDE SELLADOR	.050"	ALUMINIO EXTRUIDO	N/A
ARANDELA METÁLICA EMPOTRADA PARA AISLAMIENTO 3" 	AISLAMIENTO AL SUSTRATO	DP, DPH, HD, HD-SS, EHD, TS250	FM, MIAMI-DADE CE - ETA 19/0616 Estado de Florida - FL#: 4500	TB-75 BARRA DE TERMINACIÓN 	REBORDE SELLADOR	.075"	ALUMINIO EXTRUIDO	N/A
ARANDELA PARA AISLAMIENTO TL 3" 	PANELES CUBIERTAS, AISLAMIENTO, TALADRAR LA BASE DE LA LÁMINA A SUSTRATOS DE FIBRAS DE MADERA-CEMENTO, YESO Y CONCRETA LIVIANO	TL	FM MIAMI-DADE Estado de Florida - FL#: 4500	TB-75-SS BARRA DE TERMINACIÓN 	REBORDE SELLADOR	.075"	ACERO INOXIDABLE	N/A
ARANDELA PARA VERSA-FAST® 3" 	PANELES CUBIERTAS, AISLAMIENTO Y TALADRAR LA BASE DE LA LÁMINA AL SUSTRATOS DE CONCRETO LIVIANO Y YESO	TORNILLOS DE VERSA-FAST®	FM MIAMI-DADE Estado de Florida - FL#: 4500	TB-90 BARRA DE TERMINACIÓN 	PLANO	.090"	ALUMINIO EXTRUIDO	N/A
ARANDELA METÁLICA PARA UNIONES 2" 	MEMBRANAS DE UNA SOLA CAPA REFORZADAS O NO REFORZADAS AL SUSTRATO	HD, HD-SS, EHD, PF, TS250	FM, MIAMI-DADE CE - ETA 19/0616 Estado de Florida - FL#: 4500	TB-100 BARRA DE TERMINACIÓN 	REBORDE SELLADOR	.075"	ALUMINIO EXTRUIDO	N/A
ARANDELA METÁLICA CON PÚAS 2" 	MEMBRANAS DE UNA SOLA CAPA REFORZADAS Y BITUMINOSAS MODIFICADAS AL SUSTRATO	HD, HD-SS, EHD, PF, TS250	FM, MIAMI-DADE CE - ETA 19/0616 Estado de Florida - FL#: 4500	TB-125 BARRA DE TERMINACIÓN 	PLANO	.125"	ALUMINIO EXTRUIDO O ACERO INOXIDABLE	N/A
ARANDELA METÁLICA CON PÚAS 2.4" 	MEMBRANAS DE UNA SOLA CAPA REFORZADAS Y BITUMINOSAS MODIFICADAS A SUSTRATOS DE FIBRAS DE MADERA-CEMENTO, YESO Y CONCRETO LIVIANO	TL	FM MIAMI-DADE Estado de Florida - FL#: 4500	TB-125-SS BARRA DE TERMINACIÓN 	PLANO	.125"	ACERO INOXIDABLE	N/A
ARANDELA DE SOLDADURA POR INDUCCIÓN 	MEMBRANAS DE PVC O TPO	HD, EHD, PF	FM, MIAMI-DADE Estado de Florida - FL#: 4500	RD-100 BARRA DE DRENAJE 	RETENEDOR DE GRAVA	.125"	ALUMINIO EXTRUIDO	N/A
				LÍSTON 	PLANO O EMPOTRADA	.043"	GALVALUME®	FM MIAMI-DADE CE - ETA 19/0616 Estado de Florida - FL#: 4500-R1
				<b>HERRAMIENTAS Y ACCESORIOS</b>				
				<ul style="list-style-type: none"> <li>• HERRAMIENTA SIP SHORTY</li> <li>• HERRAMIENTA SHORTY</li> <li>• HERRAMIENTA DE PIE DE PA</li> <li>• HERRAMIENTA SETTER</li> <li>• BOLSA PA</li> <li>• HERRAMIENTA SUJETADOR DE TORNILLO BASE</li> </ul>				
				<b>TRUFAST® PA SYSTEM™</b>				
				<ul style="list-style-type: none"> <li>• PA (los sujetadores preensamblados son más rápidos de instalar que los tornillos y arandelas individuales).</li> <li>• El sistema y las herramientas no requieren de un entrenamiento especial.</li> <li>• Mejora la ergonomía y la productividad del trabajador.</li> <li>• La herramienta para trabajode pie es simple, liviana y portátil.</li> <li>• Fiable y económico en comparación con equipos automatizados complicados y engorrosos.</li> </ul>				
				<p>TRUFAST® es una marca de Altenloh, Brinck &amp; Co. US, Inc., que se especializa en soluciones y accesorios de sujeción diseñados para la industria de techos comerciales. Otras marcas de ABC US incluyen SPAX® y TRUFAST® Walls, soluciones de sujeción diseñadas para la industria de la construcción y la envolvente de edificios, respectivamente.</p>				



ALTENLOH, BRINCK & CO US, INC.

## Standard Freight & Order Policies for TRUFAST® Products

**MINIMUM ORDER: \$250.00** Orders of less than \$250 will be assessed a \$25.00 service charge.

**TERMS:** NET 30

### PRICING

Altenloh, Brinck and Company US, Inc. / TRUFAST reserves the right to adjust pricing and conditions of sale without notice.

### PRODUCT AVAILABILITY

The products and services published in the current “TRUFAST Price List”, which includes our adhesive and sealant products, are considered our standard, off-the-shelf product offering. Our goal is to maintain an inventory of these items for immediate availability; however, individual order quantities and periods of extraordinary quantity demands may create temporary inventory shortages or outages, at which time every effort will be made to satisfy customer requirements as soon as possible. To confirm product availability and order shipping, please contact our Sales/Service Department at 800-443-9602 or [salesteam@trufast.com](mailto:salesteam@trufast.com).

### FREIGHT

Freight allowed (prepaid) on orders of **\$5,000.00 minimum for continental U.S.A. and \$15,000.00 minimum for Canada**, shipping from Bryan, OH, or any of the regional warehouses.

### DISCREPANCIES

All receiving discrepancies **MUST** be reported within 48 hours of receipt. A signed BOL/delivery receipt significantly limits the ability to reconcile quantities listed on the BOL vs. quantities received with the freight carrier.

### RETURN MATERIAL POLICY

- A “Return Material Authorization” (RMA) number **MUST** be requested, approved, and issued by Altenloh, Brinck and Company US, Inc. / TRUFAST before any product is accepted for return. Only unopened original packages may be considered for a return.
- Unauthorized returns will be refused.
- Adhesive & Sealant product to be returned must be “standard” product, in “saleable” condition and **must have been purchased within the previous 60 days, and must have at least 90 days of shelf life remaining**. All other product to be returned must be “standard” product, in “saleable” condition and **must have been purchased within the previous 6 months**. Non-standard / custom items are not returnable.
- **RMA expires 30 days from date of issue. Product must be returned in this 30-day window.**
- Returned goods are subject to a 20% restocking charge and must be returned freight prepaid. Returns for reasons not the fault of TRUFAST will have any prepaid freight-out shipping charges deducted from the credit in addition to the restocking charge. We will advise total charges in advance.
- Requests and questions regarding goods should be directed to our Sales/Service Department at 800-443-9602 or [salesteam@trufast.com](mailto:salesteam@trufast.com).



### TRUFAST® Walls products



GRIP-DECK® TubeSeal



THERMAL-GRIP® ci  
PRONG WASHER



GRIP-LOK® MW PLATE

# BUILDING ENVELOPE FASTENING SOLUTIONS

TRUFAST® Walls has partnered with leading insulation, building wrap, and air/moisture barrier manufacturers and has developed fasteners and tools to rapidly install the material. TRUFAST® Walls Products are designed with energy efficiency and labor savings in mind, taking traditional installation methods and improving for better building performance.

[www.trufast.com](http://www.trufast.com)



ENGINEERED  
FASTENERS

# AMPLIFY YOUR CRAFT™

## PREMIUM QUALITY WOOD SCREWS

SPAX® fasteners are used by DIY-ers, woodworkers and pro contractors typically for residential construction and remodel projects. SPAX® fasteners can be found in big box retail, online distributors and many lumberyard builders material suppliers.

## A FASTENER FOR EVERY JOB.

Find the right screw or fastener for your next job with the largest variety of diameters, lengths and head styles in the industry.



**TRU**CONNECTION**. TRU**PERFORMANCE**. TRU**FAST****

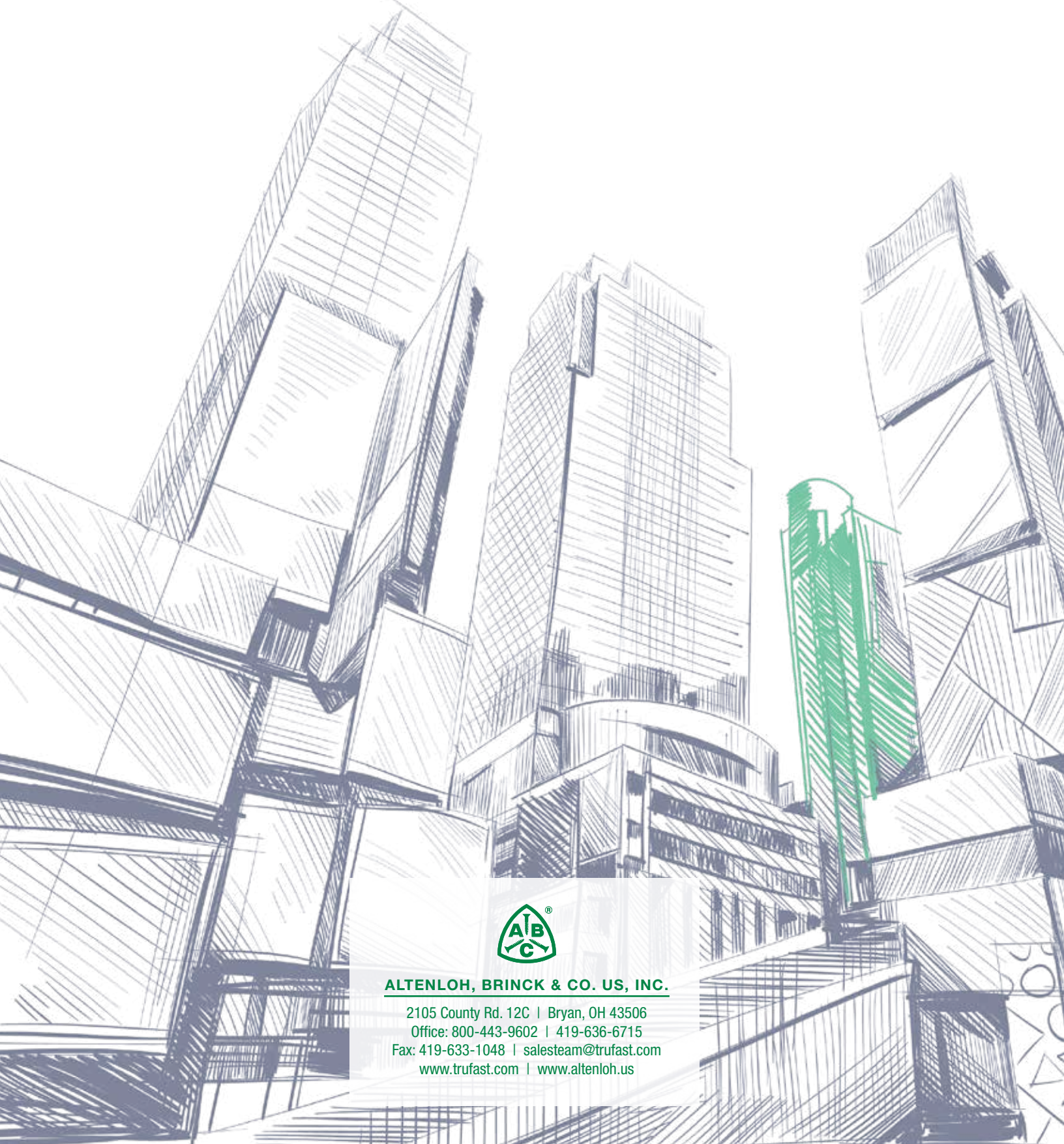

**ALTENLOH, BRINCK & CO. US, INC.**

2105 County Rd. 12C | Bryan, OH 43506  
Office: 800-443-9602 | 419-636-6715  
Fax: 419-633-1048 | [salesteam@trufast.com](mailto:salesteam@trufast.com)  
[www.trufast.com](http://www.trufast.com) | [www.altenloh.us](http://www.altenloh.us)

